



Calibre Solutions Ltd
145 Hepburn Rd, Waitakere 0602

Freephone: 0800 422 542
Phone: +64 9 813 1303
Fax: +64 9 813 1319

Installation Instructions **Smoothflow SashDrive Fume Cupboard**

Refer drawing on next page

1. Set under-bench frame in position. Check that the lower cross bar is at the rear, and the service panel is to front. Adjust the feet for level and height (870mm)
2. Place fume cupboard on under-bench frame. Align, and screw through lugs on frame into base of fume cupboard. Maximum screw length 20mm!
3. Plumb up from top of fume cupboard for duct. Mark and cut 260mm dia hole through ceiling and roof.
4. Above the roof, and within about 1m of the hole, construct a level platform for the fan. The platform may be timber, or galvanised or stainless steel. The fan weighs 28kg, and the stack and cowl is about 17kg. (45kg total)
Place the fan on the platform with the inlet in line with the hole.
Mark out the four fixing points, and move the fan aside.
Fix the rubber mounts (provided with fan) to the platform.
Replace the fan in position and fix to the rubber mounts with s/s bolts provided.
5. The cowl must terminate 3m above the roof penetration. Temporarily place cowl on top of fan. Measure height above roof penetration and calculate length of stack required. Add 100mm for sockets.

Cut 250mm dia duct to length. Ensure ends are cut square. De-burr edges.
Fit the cowl and the duct to the fan outlet. Ensure the duct is plumb. Use PVC solvent cement, or hot-air welding.
6. Temporarily place bend in line with fan inlet and roof penetration. Measure up from fume cupboard outlet to bend. Allow for sockets at each end. Cut 250mm dia duct to length. Ensure ends are cut square. De-burr edges.

Lower duct through roof. Fit the ceiling flange over the bottom end of the duct, and fit the duct to the fume cupboard outlet. Fix the flange to the ceiling with screws or adhesive.

Fit the "Dektite" flashing over the top end of the duct, and fix to the roof with sealant and screws or rivets.

Temporarily fit the bend to the riser duct. Measure from the socket of the bend to the fan inlet, allowing a gap of 100mm between the fan and duct for the flexible connector. Cut 250mm dia duct to length. Ensure ends are cut square. De-burr edges.

Fix the duct into the bend with PVC solvent cement, or hot-air welding, and connect the duct to the fan with the flexible connector. Fasten the stainless steel clamp bands.

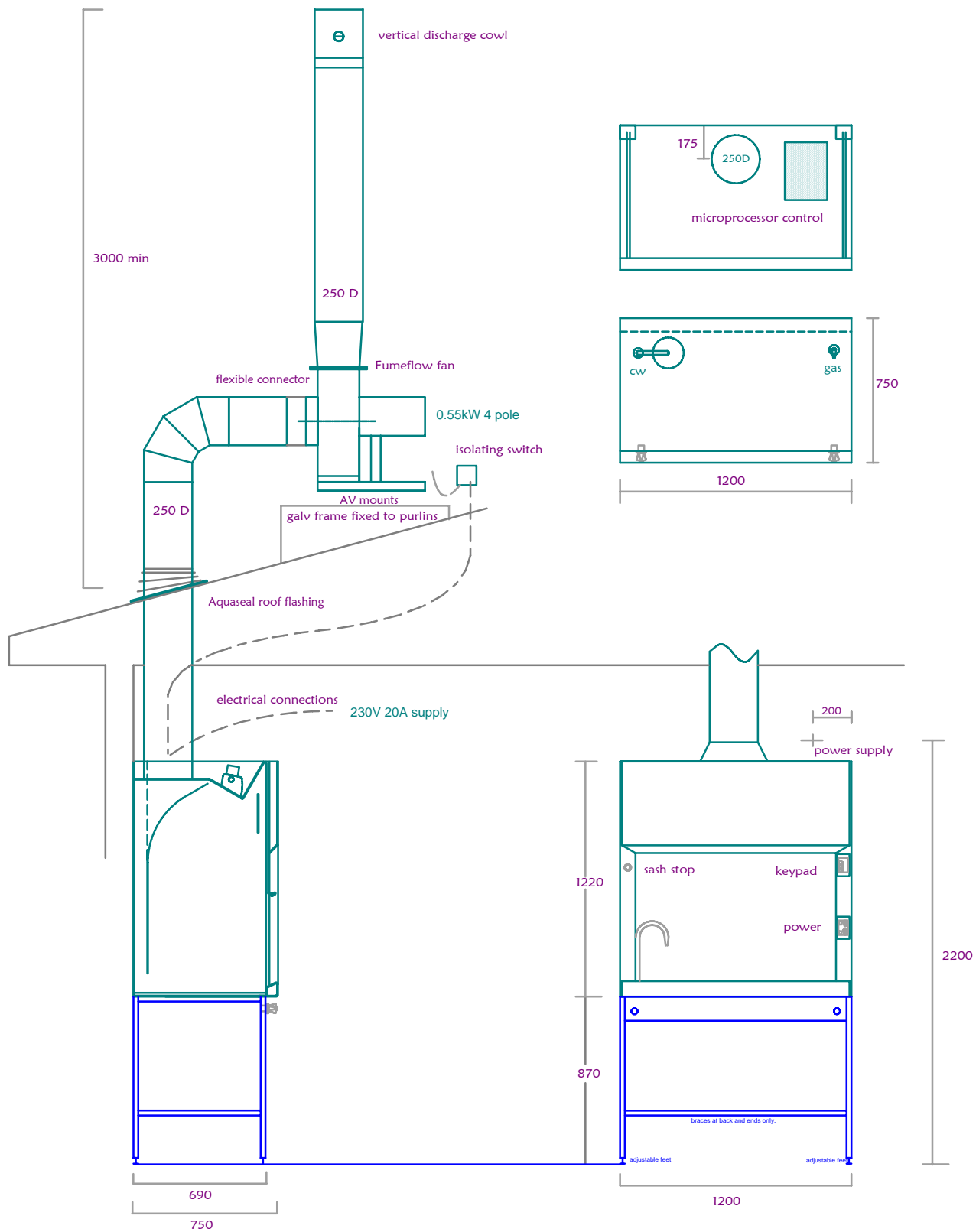

Calibre Solutions
 SashDrive Fume Cupboard Installation

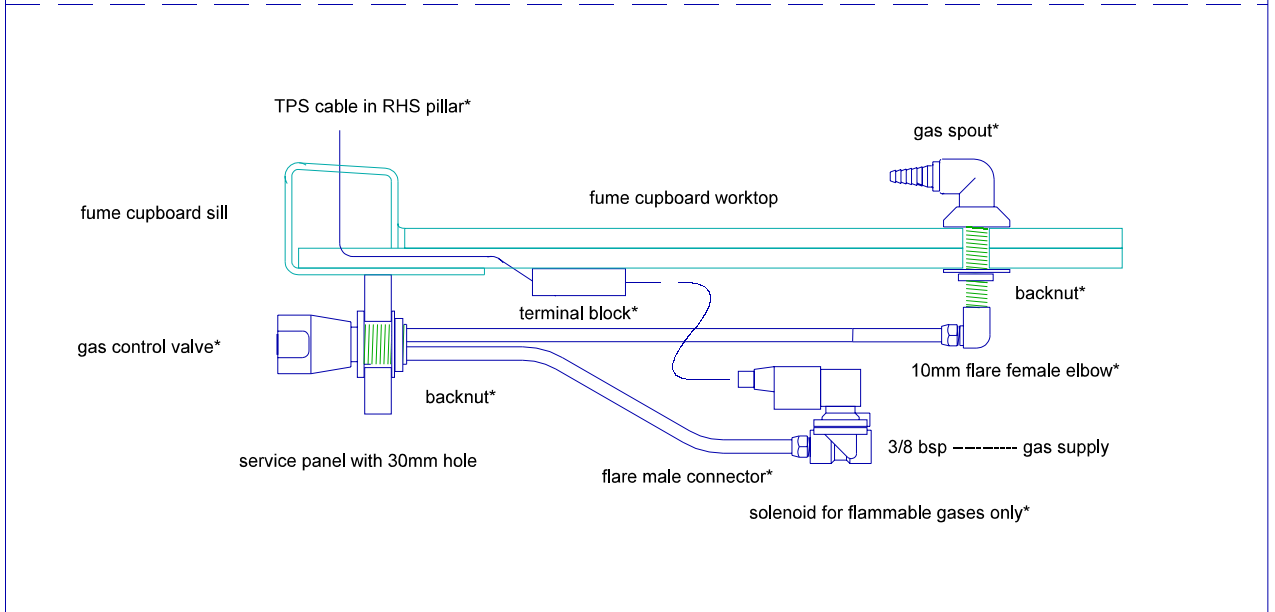
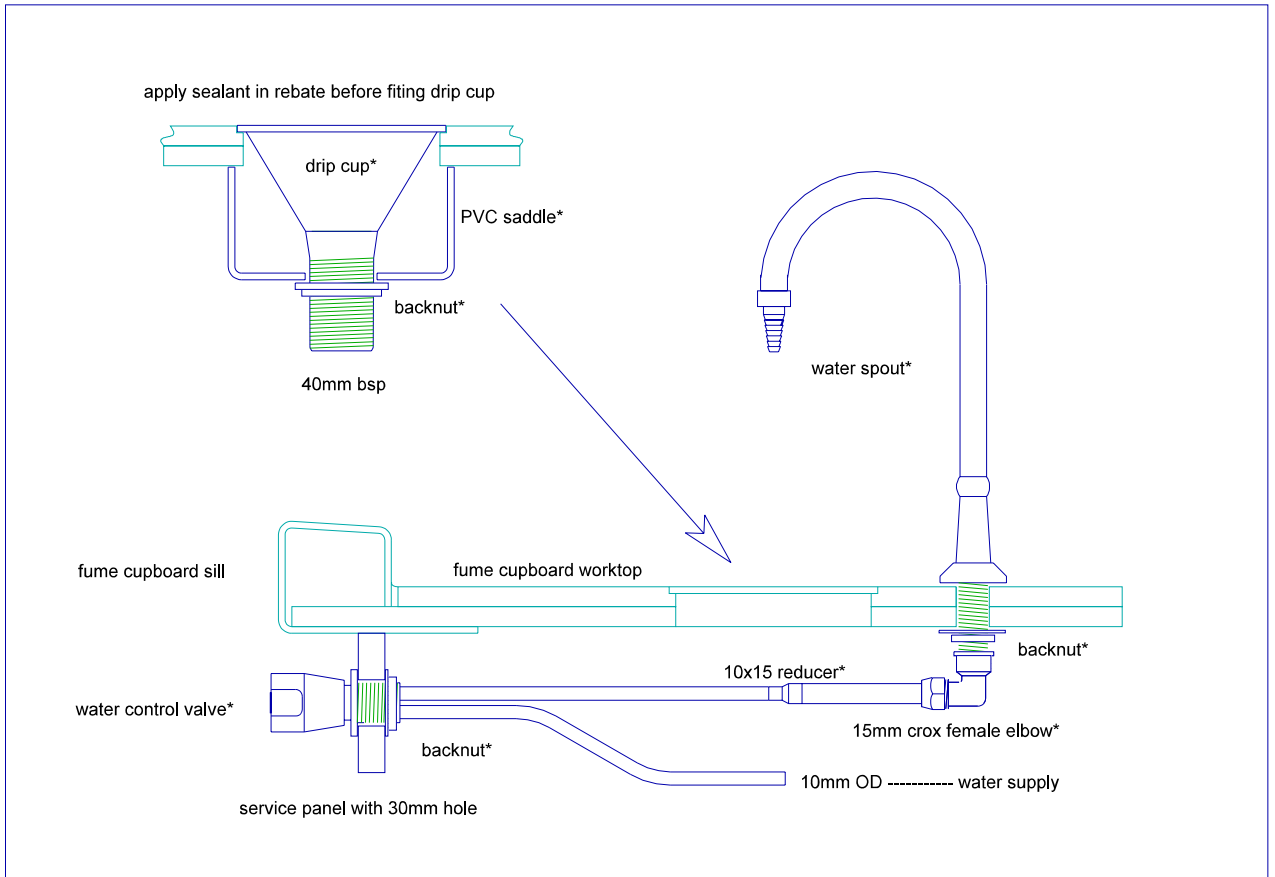

* fittings supplied with fume cupboard

Calibre Plastics Ltd
Fume Cupboard Plumbing Connections

Electrical Connections for Sashdrive Fume Cupboard

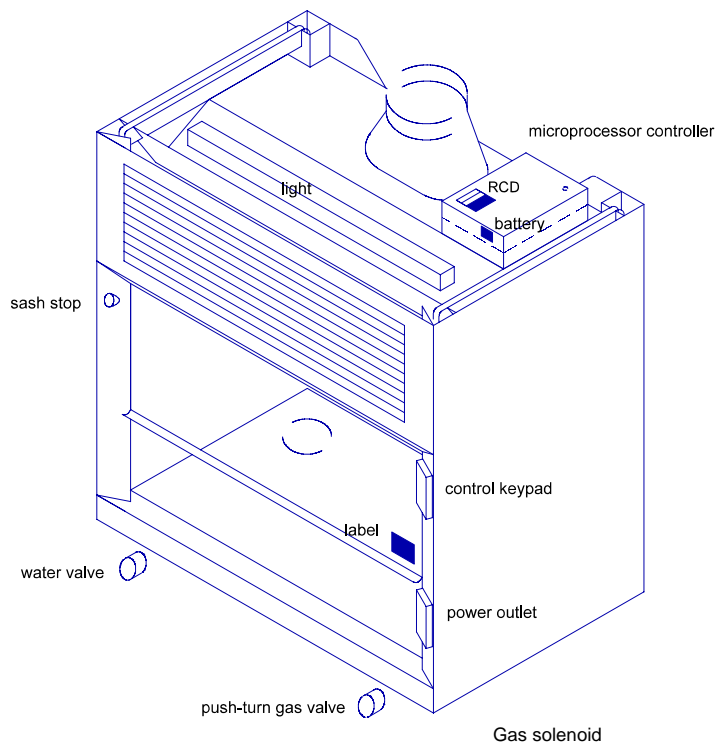
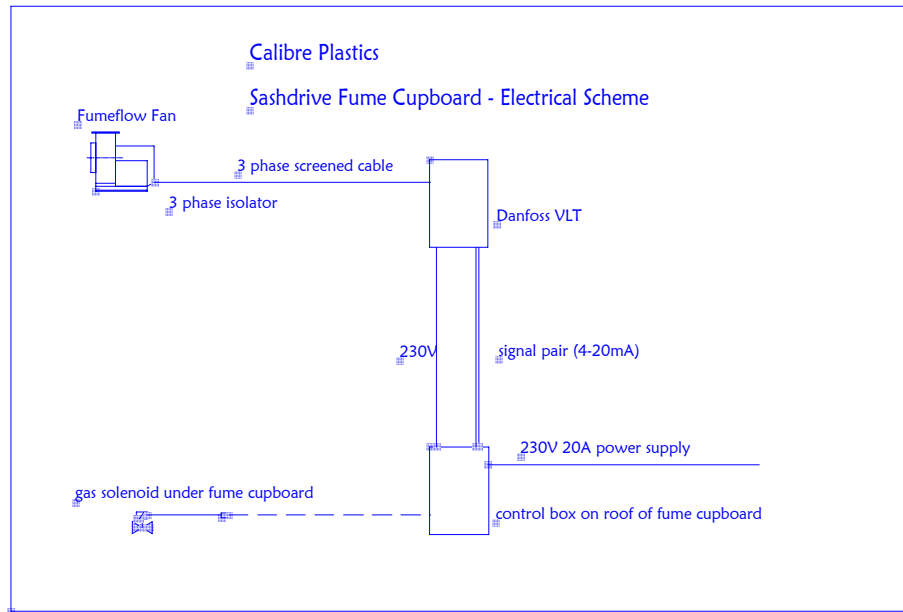

Electrical Connections for Sashdrive Fume Cupboard

The control box is a grey plastic enclosure located on top of the fume chamber. Refer the diagram. The control box contains

- a local isolator,
- a circuit breaker for the fan,
- an RCD circuit breaker for the power socket
- a grey fuse holder (500mA)
- coloured strip connectors for Neutral and Earth
- a transformer
- a printed circuit board with a row of relays along the (left) side
- a smaller printed circuit board in the lid (airflow control)

The VSD requires a 230V single phase power supply, a signal pair, and a three phase shielded connection to the fan motor.

Mount the VSD in an accessible place for programming.

Provide and terminate a 3 core cable $\geq 1 \text{ mm}^2$ from the VSD to the fume cupboard controller.

The fume cupboard controller has a cable entry at the front right.

Terminate the VSD Neutral conductor at the blue terminal block

Terminate the VSD Earth conductor at the yellow/green terminal block

Terminate the VSD Active conductor at the 10A circuit breaker (see diagram)

Provide and terminate a 2 core signal cable from the **OUTPUT** terminals on the flow control circuit board in the lid of the fume cupboard controller to terminals **55&60** of the Danfoss VSD .

FAN The fan is located above the roof.

The fan has a 3 phase motor

Ensure the motor is configured in delta for 230V

Optionally provide a weatherproof isolating switch by the motor

Provide and terminate a 4 core shielded cable from the fan to the VSD output terminals.

Ground the cable shield either to the motor or the VSD but not both.

FUME CUPBOARD POWER SUPPLY

Required supply is 230V 50Hz, 20A

Provide and terminate a 3 core cable $\geq 2.5 \text{ mm}^2$ from the mains distribution board to the fume cupboard controller.

This circuit should be fused at 20A.

The fume cupboard controller has a cable entry at the front right.

Terminate the fan Neutral conductor at the blue terminal block

Terminate the fan Earth conductor at the yellow/green terminal block

Terminate the fan Active conductor at the isolator switch P (see diagram)

GAS SOLENOID

There is a TPS cable under the right front corner of the fume cupboard

Connect the gas solenoid(s) to this cable using the junction box provided

CHECK Check that all screw terminals are tight

Check the air flow pilot tube is not kinked

Check that installation of the duct and fan is complete

Turn on the fan isolating switch.

Read the operating instructions before switching on the power.

Check the fan rotation.

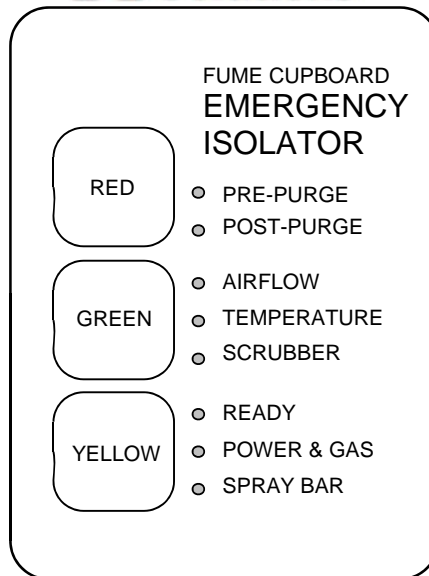

OPERATING THE FUME CUPBOARD

- Start up** Press the green button
The fan and light turn on
The **TEMPERATURE LED** will be green
The controller waits 7 seconds for airflow
- Pre-purge** The **AIRFLOW LED** turns green
The **PRE-PURGE LED** will be amber for 50 seconds
then flash for another 10 seconds, then go out
- Ready** The **READY LED** turns green
Four beeps sound
- Active** Press the yellow button
The **POWER & GAS LED** turns green
The fume cupboard is now operational -
power & gas can be used
- Shut down** Press the red button
Power & Gas turn off automatically
The **POWER & GAS LED** goes out
- Post-purge** The fan and light continue to operate
The **POST-PURGE LED** will be amber for 15 minutes
then flash for another 5 minutes, then go out.
The light and fan turn off automatically
- Re-start** Press the green button to return from
post-purge to pre-purge

Sashdrive variable speed fan control

The fume cupboard sash has an electronic sensor.
The fan speed is regulated to suit the sash opening.
Lower the sash to save energy loss from the room

FAULT ALARMS

If the **Power** is cut, an alarm will sound a slow beep

The **READY LED** will flash red

Press the red button to mute the alarm

A long beep will sound as the controller shuts down.

When the **Power** is restored,

The fan will automatically turn on for 20 minutes then turn off;

An alarm will sound for 30 seconds, then turn off

The **LED's** will keep flashing.

Press the red button to reset the controller and stop the fan.

Press the green button for normal start up.

If the **Airflow** gets low

An alarm will sound , and the **AIRFLOW LED** will flash

Press the red button to mute the alarm

The fume cupboard will go into normal post-purge,

but the **AIRFLOW LED** will be red

Check out what caused the alarm.

Get it fixed before using the fume cupboard again.

If the **Temperature** inside the fume cupboard gets high

The **TEMPERATURE LED** will flash green as a warning

Turn down the heat inside the fume cupboard

If the temperature inside the fume cupboard gets higher

An alarm will sound , and the **TEMPERATURE LED** will flash

Press the red button to mute the alarm

The fume cupboard will go into normal post-purge,

but the **TEMPERATURE LED** will be red

Check out what caused the alarm.

Get it fixed before using the fume cupboard again.

The temperature sensor works even when the fume cupboard is turned off.

Press the red button to mute the alarm

TROUBLE SHOOTING

No power at power socket

Power is made available to the socket outlet only during “Active” status. Refer operating instructions. After the pre-purge is complete and ‘Ready’ status is displayed, press the yellow button to activate the power outlet.

If ‘Active’ status is displayed and there is still no power, check the RCD breaker (the blue switch visible in the lid of the control box on top of the fume cupboard).

When it is on, the switch lever is inclined toward the back of the fume cupboard. If the switch will not latch on, there is an electrical fault in the circuit. Call an electrician.

No gas at gas outlet

Gas is made available to the outlet only during “Active” status. Refer operating instructions. After the pre-purge is complete and ‘Ready’ status is displayed, press the yellow button to activate the power outlet.

If ‘Active’ status is displayed and there is still no gas, check the RCD breaker (the blue switch visible in the lid of the control box on top of the fume cupboard).

When it is on, the switch lever is inclined toward the back of the fume cupboard. If the switch will not latch on, there is an electrical fault in the circuit. Call an electrician.

If the power socket is live but there is still no gas, the gas mains may be isolated. Some laboratories have a master gas isolator.

Controller does not respond to keypad

If the control sequence has become corrupted, the controller needs to re-load the program from memory, which happens automatically on power restore.

The mains isolator switch is visible in the lid of the control box on top of the fume cupboard. The mains isolator is the switch on the left. When it is on, the switch lever is inclined toward the back of the fume cupboard.

Turn off mains supply to the fume cupboard controller. Wait 5 seconds, then turn the mains isolator on again. The processor will reboot, and signal a power restore alarm (see operating instructions) Press the red button to reset the controller, and start the fume cupboard as normal.

COMMISSIONING

Refer the operating instructions appended
Turn the power on and reset the controller.
Manually start the VSD, and check fan rotation.
Start the fume cupboard controller.
If the airflow alarm goes off, mute the alarm.

Measure the airflow

Raise the sash to the maximum operating position (sash stop)
Measure the air velocity in the plane of the sash at six (6) positions

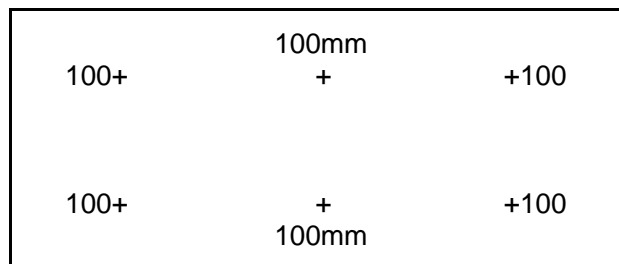

The average velocity (sash open) should be more than 0.5m/sec
Lower the sash to the minimum position (sash stop)
Measure the air velocity in the plane of the sash at 3 positions

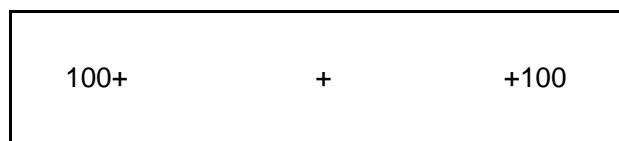

The average velocity (sash closed) should be more than 0.75m/sec
Adjust fan speed range by program limits on VSD

Record the velocity measurements in a commissioning report.
Conduct a smoke test (AS 2243.8) and record the observations.

Adjust the airflow sensor:

The airflow sensor is mounted on the roof of the fume chamber at the right end of the light panel, under a loose cover. It measures the velocity of air passing into the fume chamber through an opening in the sensor circuit board.
When the velocity is below the set point, a red LED lights up.

Adjust the velocity set point

There is a 10 turn trimpot on the sensor circuit board beside the cable
Adjust the alarm set trimpot - anti-clockwise lowers the set point
To check the alarm, cover the hole on the sensor with clean dry paper to obstruct airflow. The red LED should light up after a short delay of 5 sec